

Astramax HD-LED[®]

Surgical Light

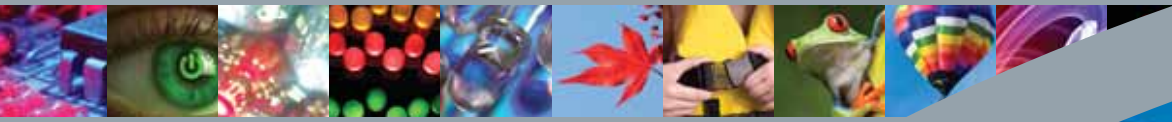

AstraMax HD-LED Surgical
Light Demonstration Video



HD
LED[®]

High Definition
LED Lighting





**HD
LED**®

High-Definition Surgical Lighting

"HD-LED is a brand new technology with vastly better performance than standard definition LED or conventional surgical lights."



Full Spectrum Colour Rendition

The only surgical lighting with near perfect colour rendition across the full visible spectrum. Natural white light picks out all the visible colours for your eyes so you can clearly see without eye strain.

- Easy to distinguish small differences in tissue
- All the colours are strong and vibrant
- Reduced eye strain by making the light do the work instead of the eye



Fat Beam Illumination

More light flux provides the biggest beams of light in the business, bigger illuminated fields and more light across the full width of the illuminated area.

- High light intensity across the full illuminated area for uniform vision
- Avoids visual distraction by reducing high contrast in the illuminated area
- Adjust the beam size to suit your working area to eliminate peripheral distraction



Red Balance Control

The highest R₉ red colour rendition of any other product provides the optimum visualisation of red tissues. Red balance enhancement compensates for our natural weakness in distinguishing shades of red and is user adjustable to fine tune the light to match our own red vision and the surgical conditions.

- Enhanced visualisation of red tissues
- Improved differentiation between tissues of similar colour
- You can adjust the light colour to match your own optical colour response



Astramax HD-LED® - *High performance compact*

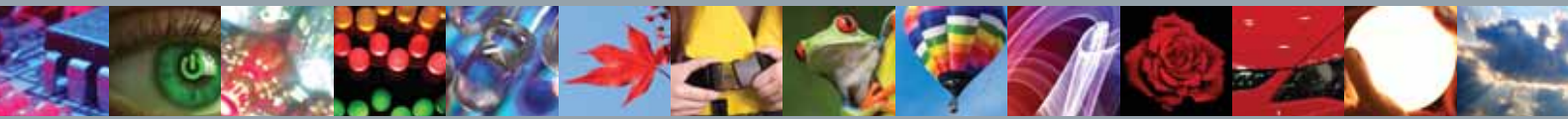

Slim, Compact, Powerful

Ultra slim and light-weight lamp head enables smooth, fast and precise positioning during procedures. Astramax HD-LED is a compact yet powerful surgical light with an impressive 140,000 Lux output comparable with much larger surgical lights.

Long Life

Astramax LED life of 40,000 hours equates to more than 20 years of normal use.

Environmentally Friendly

HD-LED® lights use up to 70% less energy than conventional medical lighting. HD-LED lights have the highest lighting performance with the smallest energy consumption.

LED's are also mercury free, do not contain CFCs, POPs, VOCs, halogens or other harmful chemicals and are ROHS compliant.





Shadow Control

By spreading the LED's across the whole lighting surface, a much better distribution of light is provided from the lamphead. This enables excellent shadow control to under-light obstructions during procedures.

Large Movement Range

Astramax HD-LED lamp head is mounted on multi-movement arm mechanisms capable of positioning the lamp head within an exceptionally wide envelope of movement. The lamp has 5 rotations to allow easy positioning of the light beam from any angle.

Economical

Astramax HD-LED provides exceptional performance at a competitive price with minimal running costs. Using less than 50 Watts of power and with 40,000 hours of LED life, Astramax continually saves money on energy and maintenance.

Infection Control

The lamp head is sealed to IP54 to protect from ingress of dirt and fluids. The smooth surfaces of the lamp head allow for easy disinfection. The lamp head is manoeuvred using a sterilisable handle.



Astramax HD-LED® - Technical Information

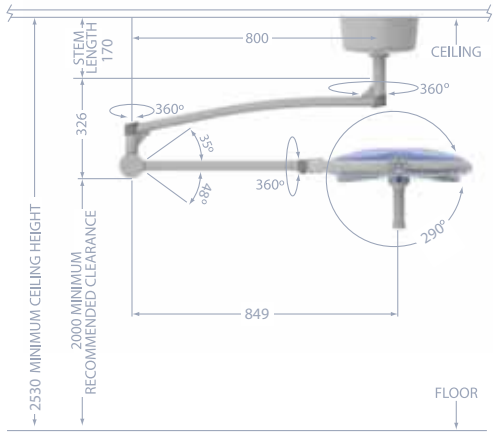
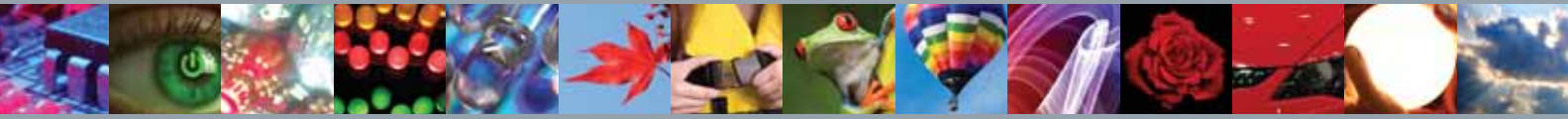

Single Ceiling

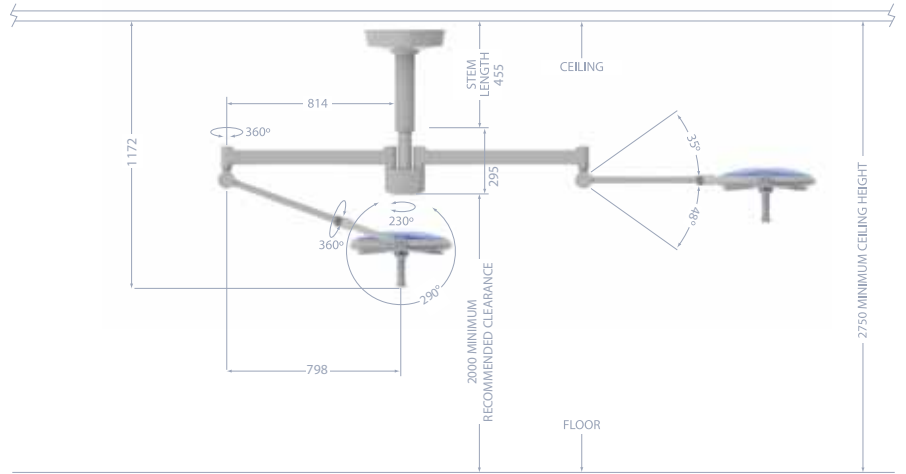

Tandem Ceiling Mount

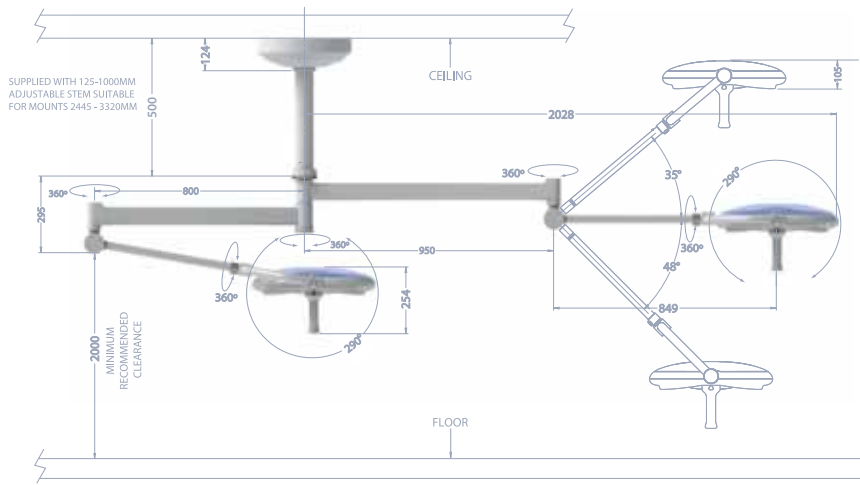

Duo Ceiling Mount

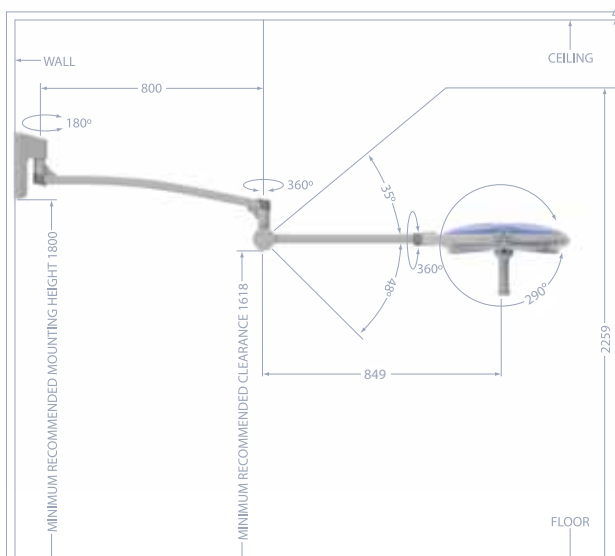

Single Wall Mount

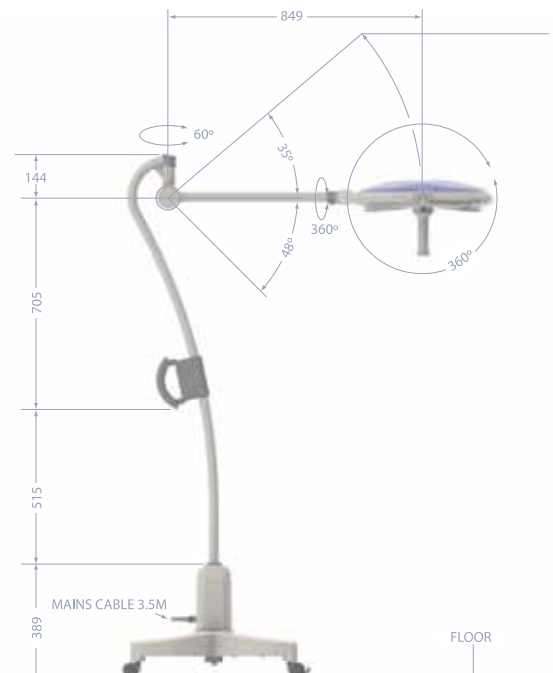



Single Mobile

* NOTE MOVEMENT DIMENSIONS ARE APPROXIMATE AND SUBJECT TO MANUFACTURING VARIANCES OF $\pm 10\%$



The light intensity can be altered through 5 easily selectable settings between 5% and 100%, providing the most suitable intensity for any type of procedure.









Data Common To All Models		
Lux	1m	140,000
Colour Rendition Index	Ra	95
Colour Rendition (Red)	R9	98
Colour Temperature	Kelvin	3700-5000 nom
LED life	Hours	40,000 Hours
Power Consumption	Watts	< 50
Radiant Energy	mW/m².Lux	3.31
Endoscopy Setting		5%
Beam Size	D10	140 – 310mm
Shadow Control		IEC60601-2-41

Red Balance Control		
		
Enhanced Red 3,700 °K	Neutral Red 4,500 °K	Reduced Red 5,000 °K

The % of visible red light can be increased or decreased to optimise the visualisation of red tissues. Colour temperature is variable from 3,700 – 5,000°K.

CRI

R _a
95

Full Spectrum Colour Rendition							
							
R ₁	R ₂	R ₃	R ₄	R ₅	R ₆	R ₇	R ₈
97	97	97	92	94	94	94	95

RED

R ₉
98

Colour Rendering Index R_a

Colour Rendering Index (R_a) is a measure of how well a light source reproduces colours.

Near Perfect Colour Rendition Across the Visible Spectrum R₁-R₈

HD-LED has near perfect colour rendition for all 8 colour measurements used to calculate general Colour Rendering Index (R_a). The "strong red" colour so important for visualisation of red tissues is not included in the R_a measurement

Enhanced Red Balance R₉

R₉ indicates visible red colour reproduction which is a critical parameter for surgical lights.

Product Catalogue Numbers	
AMAX30FCJ	AstraMax Ceiling Mounted Surgical Lamp
AMAX30FW	AstraMax Wall Mounted Surgical Lamp
AMAX30FM	AstraMax Mobile Mounted Surgical Lamp
AMAX30FMEL	AstraMax Mobile Mounted Surgical Lamp with Emergency Power Supply Unit
AMAX3030FTJ	AstraMax Tandem Ceiling Mounted Surgical Lamp
AMAX3030FUJ	AstraMax Duo 360° Mounted Surgical Lamp
AMAX3030FD	AstraMax Tandem Ceiling Mounted Surgical Lamp with Media Accessory Arm

Quality, Safety and Reliability

Astramax is designed to comply with all existing and foreseeable International Standards in terms of safety and performance. The quality of design, manufacture, installation and after sales service is strictly regulated by ISO 13485 and ISO 9000 quality systems. The CE mark is your guarantee that Astramax meets or exceeds all European Union requirements for operating theatre lights.



HD LED®

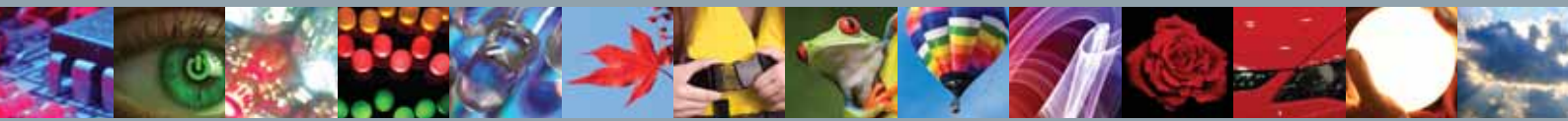

 <p>AZIENDA CON SISTEMA DI GESTIONE QUALITÀ CERTIFICATO DA DNV GL = ISO 9001 =</p>	<p>DISTRIBUZIONE APPARECCHIATURE E PRODOTTI PER IL SETTORE DENTALE E MEDICALE</p>	<p>De Marco s.r.l. 20133 Milano Via Tajani, 9 Tel. +39 02719065 +39 0270100417 Fax. +39 02733109 demarco@demarco.biz - www.demarco.biz</p>
---	---	--

AstraMax HD-LED Surgical
Light Demonstration Video



Brandon Medical Co Ltd, Elmfield Road, Morley, Leeds, LS27 0EL
T: +44 (0)845 1243 666 F: +44 (0)845 1243 667
T: +44 (0)113 2777 393 F: +44 (0)113 2728 844
E: enquiries@brandon-medical.com
www.brandon-medical.com

In line with the Brandon policy of progressive improvement, the right is reserved to alter specifications and/or prices without notice.

Brandon Medical, HD-LED, Astramax and Symposia are registered trademarks of Brandon Medical Co Ltd.